

MICRO ATX MINI TOWER
COMPUTER CASE

P30

- Modern and Clean Aesthetic
- **Panoramic View** with Seamless Tempered Glasses (Front/Side)
- Maximized Ventilation and Airflow
- Excellent Expandability and Convenience
- Intuitive Cable Management Layout





Modern and Clean Aesthetic

Designed for maximum desk appeal showcasing components

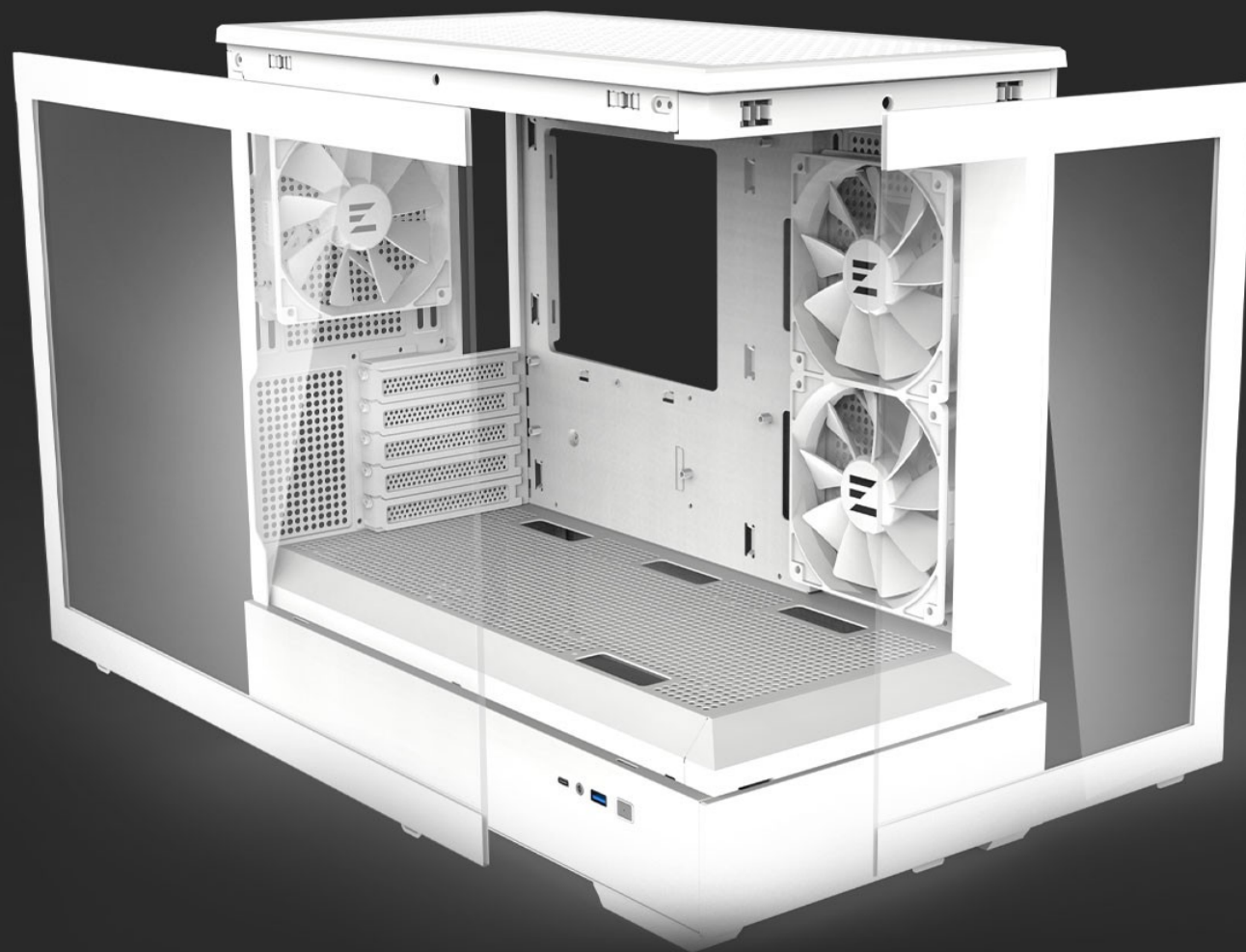

**Panoramic View with
Seamless Tempered Glasses**

Two frameless front and side tempered glasses
showing unique PC build

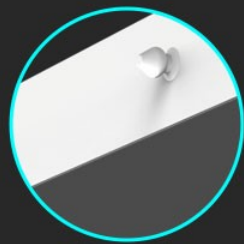

Tool-free ball head structured front and side tempered glass enhances user's convenience

Tool-Free Tempered Glasses

The front and side panels can be easily and completely removed for convenient access to PC components



Easy panel management with groove fixing structure at the bottom of the tempered glass



Maximized Ventilation and Airflow



Side : Reverse 120mm ARGB Fan x 2



Rear : 120mm ARGB Fan x 1



Side / Rear (120mm ARGB Fan)

- Dimensions : 120 x 120 x 25(T)mm
- Rated Voltage : DC 12V
- Fan Speed : Max. 1,100RPM +- 10%
- Air Flow : Max. 42.1CFM
- Bearing Type : Hydro Bearing
- Connector : System 3-Pin / LED 5V 3-Pin

Pre-installed 3 x 120mm addressable RGB fans provide full customization via a 3-pin header connection

Two 120mm reverse fans on the side effectively pull fresh air from the outside into chassis, while the rear fan blows hot air out to maximize air flow and cooling performance

Excellent Expandability and Convenience

The P30 has plenty of space to offer upgraded performance features, compatibility with high-end PC components, and even custom liquid cooling



Complete Dust Protection

Dust Filter on the Top

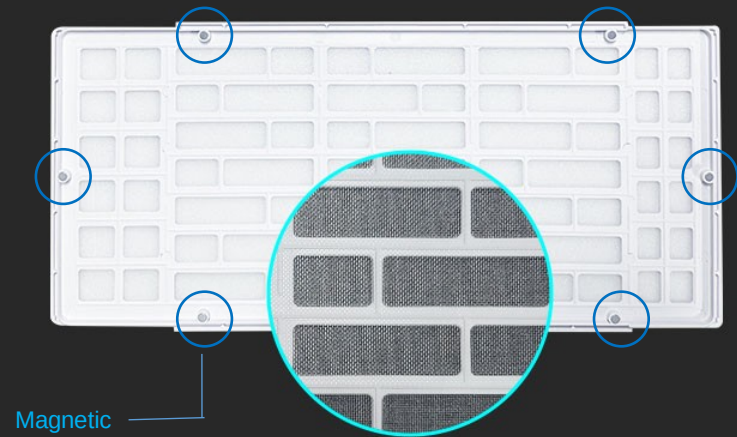
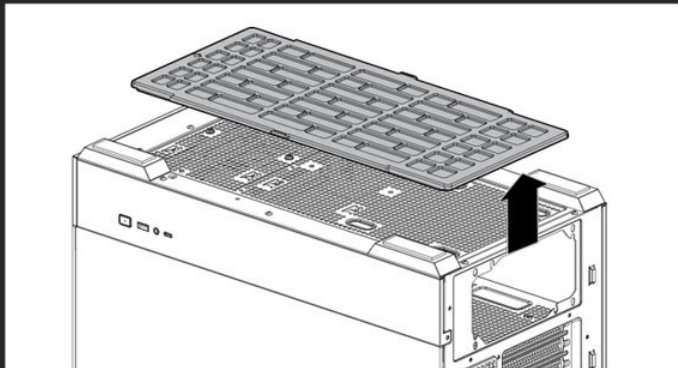
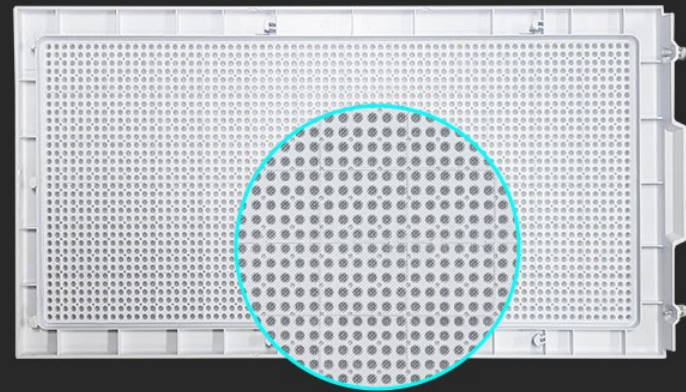
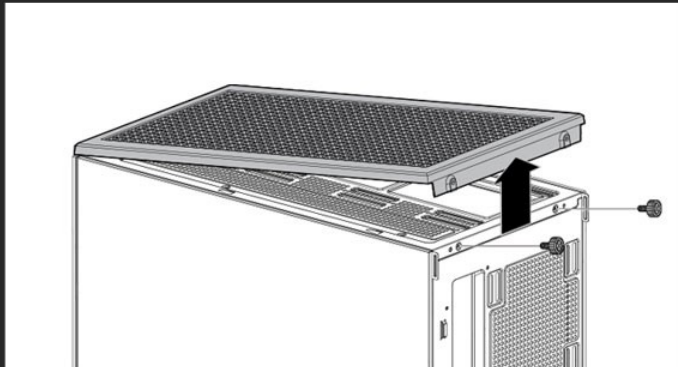

Dust Filter on the bottom

Top, bottom and side panels with study dust filters prevent any dust

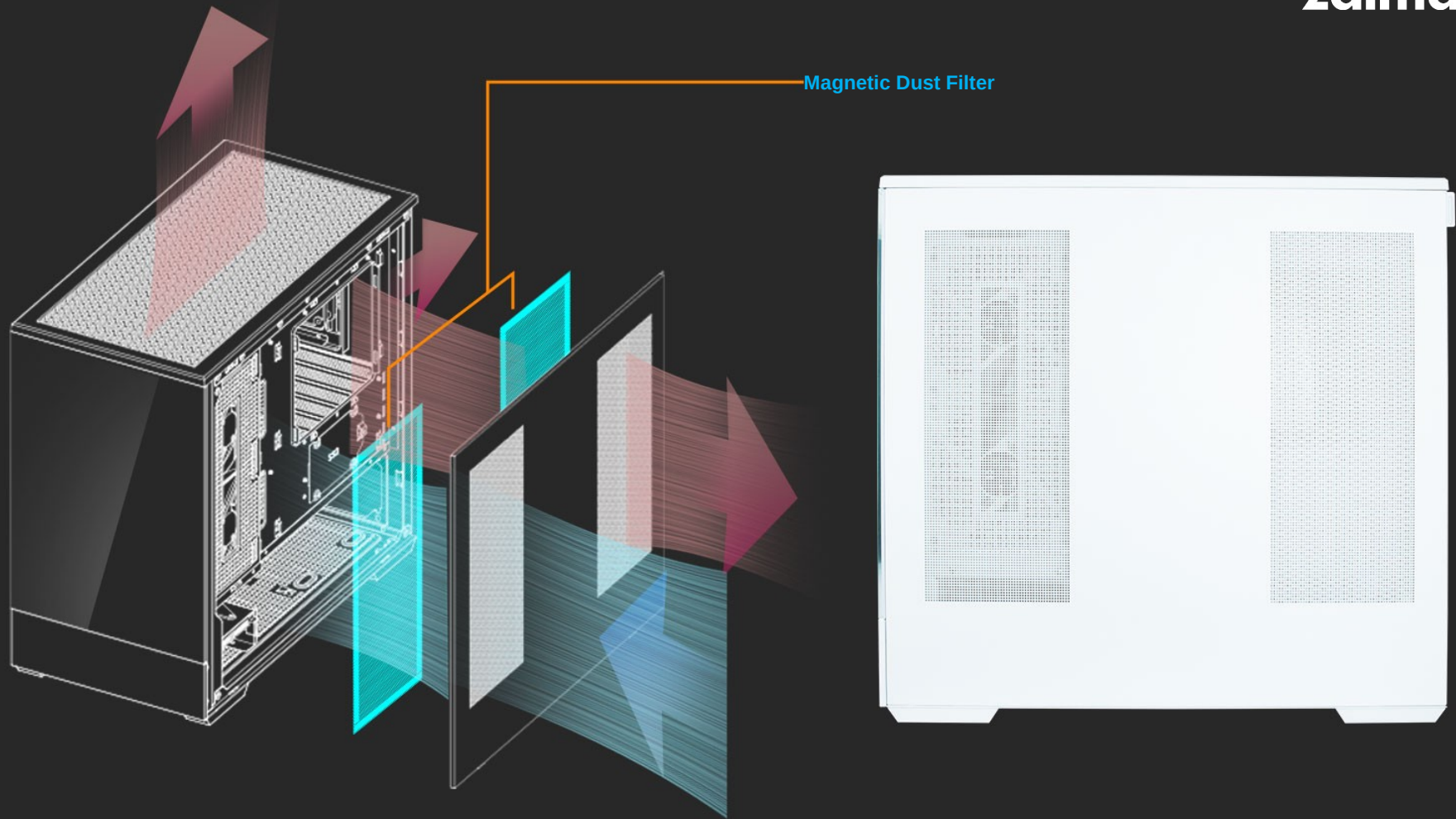

Magnetic Dust Filter

Unrestricted Cooling Potential

Steel side panel with two separate air-vents provides enhanced ventilation and additional airflow to system

Intuitive Cable Management Layout

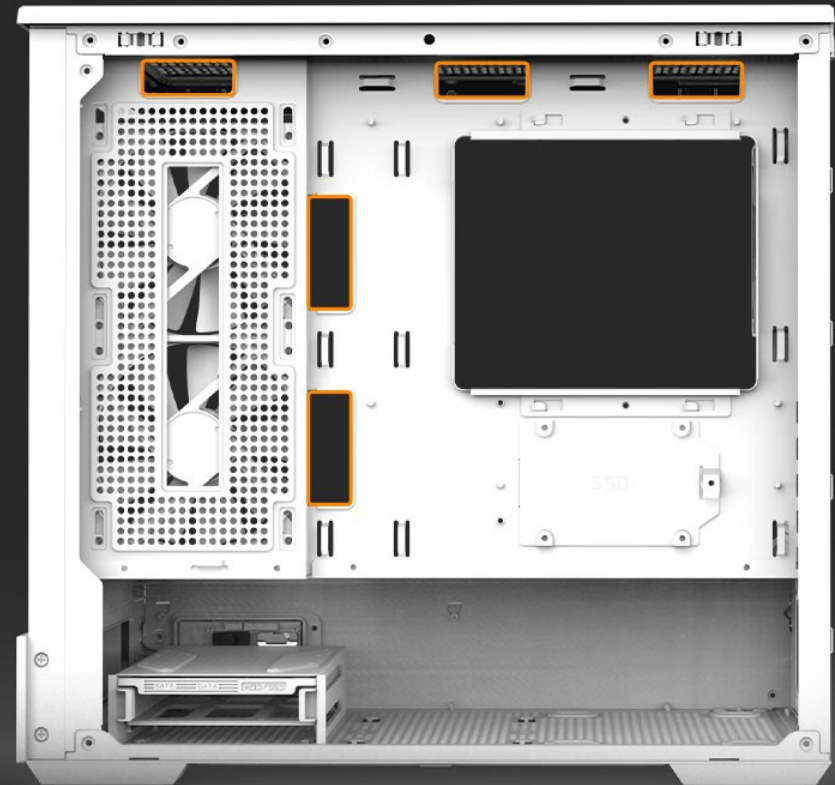

Convenient cable management layout makes it easier than ever to organize messy cables for a clean look



Easy accessible I/O ports

- Ⓐ USB Type C
- Ⓑ Microphone / Headphone Jack
- Ⓒ USB 3.0
- Ⓓ Power Button

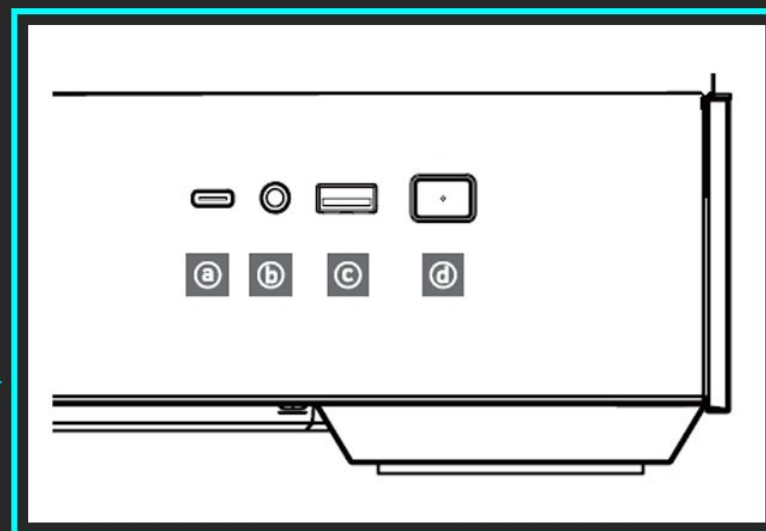

Motherboard Support

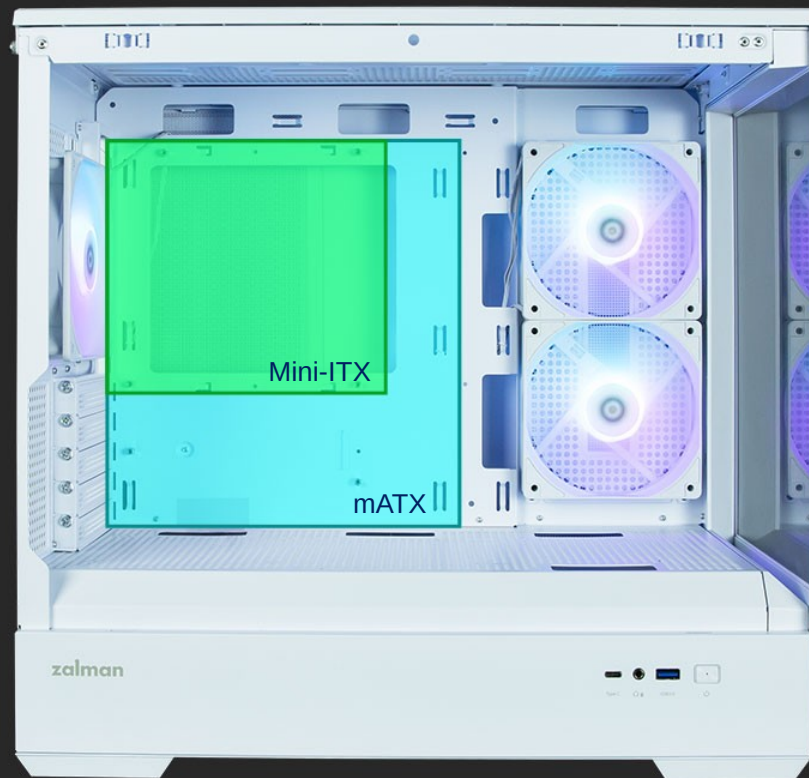

Mini-ITX



mATX

Components Clearance

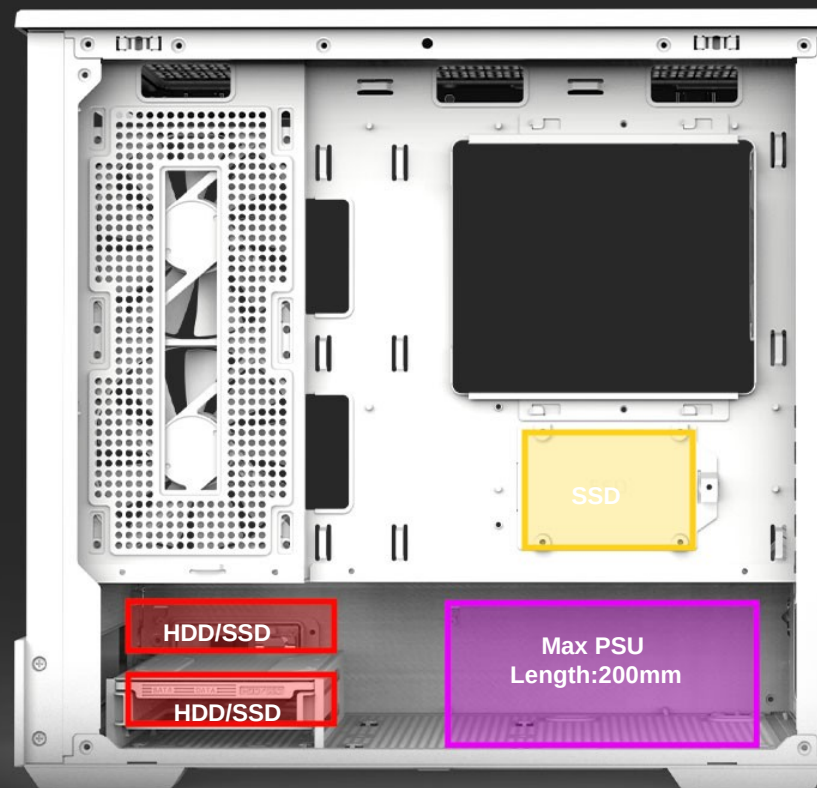
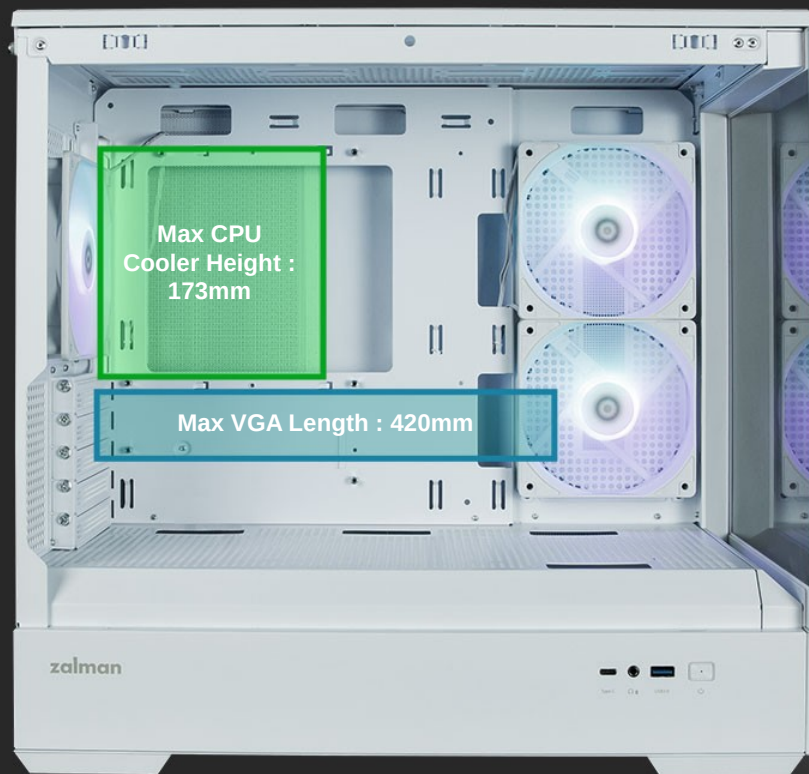

Max CPU Cooler Height

173mm

Max VGA Card Length

420mm

MAX PSU Length

200mm

Drive Memory Support

Supports up to 2 x 3.5" HDD / 3 x 2.5" SSD

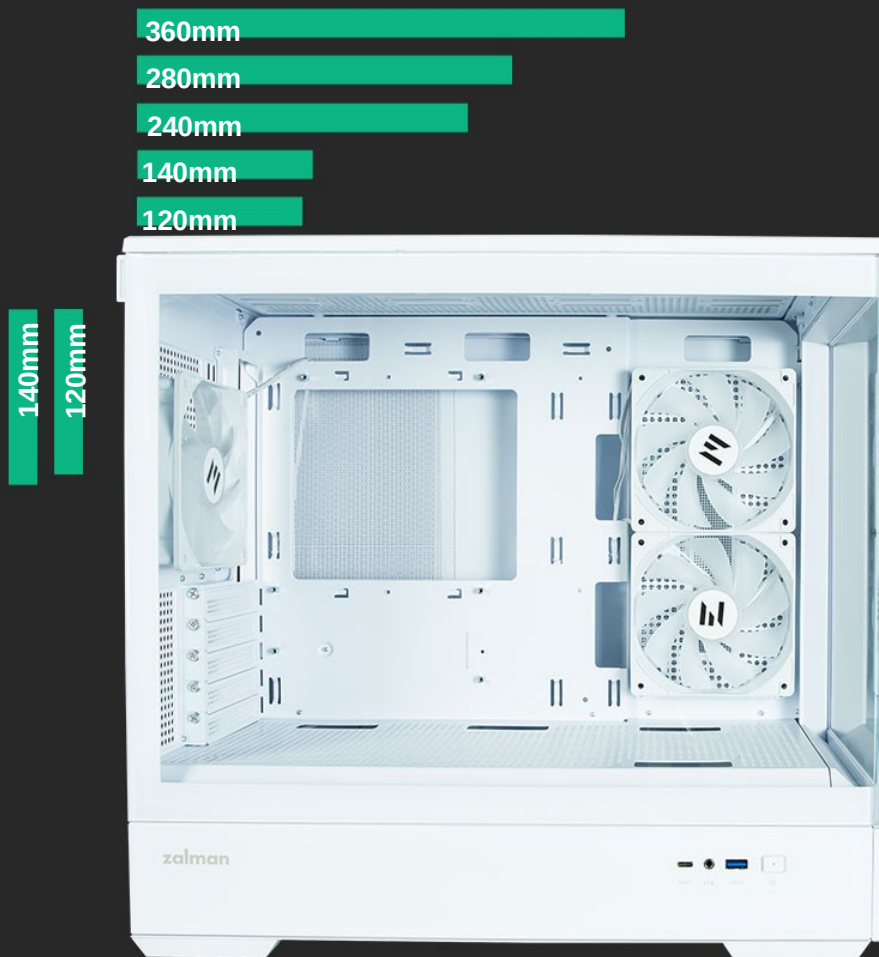

Radiator Configuration

Top : 120mm / 140mm / 240mm / 280mm / 360mm

Rear : 120mm / 140mm

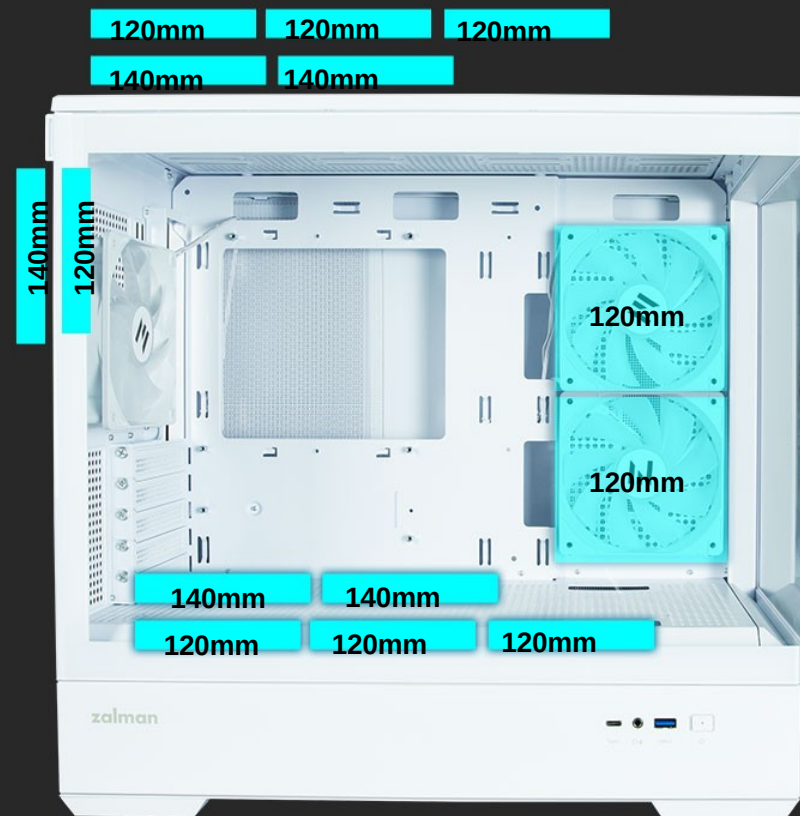

Fan Support

Top : 3 x 120mm / 2 x 140mm

Rear : 1 x 120mm / 1 x 140mm

Bottom : 3 x 120mm / 2 x 140mm

Side : 2 x 120mm

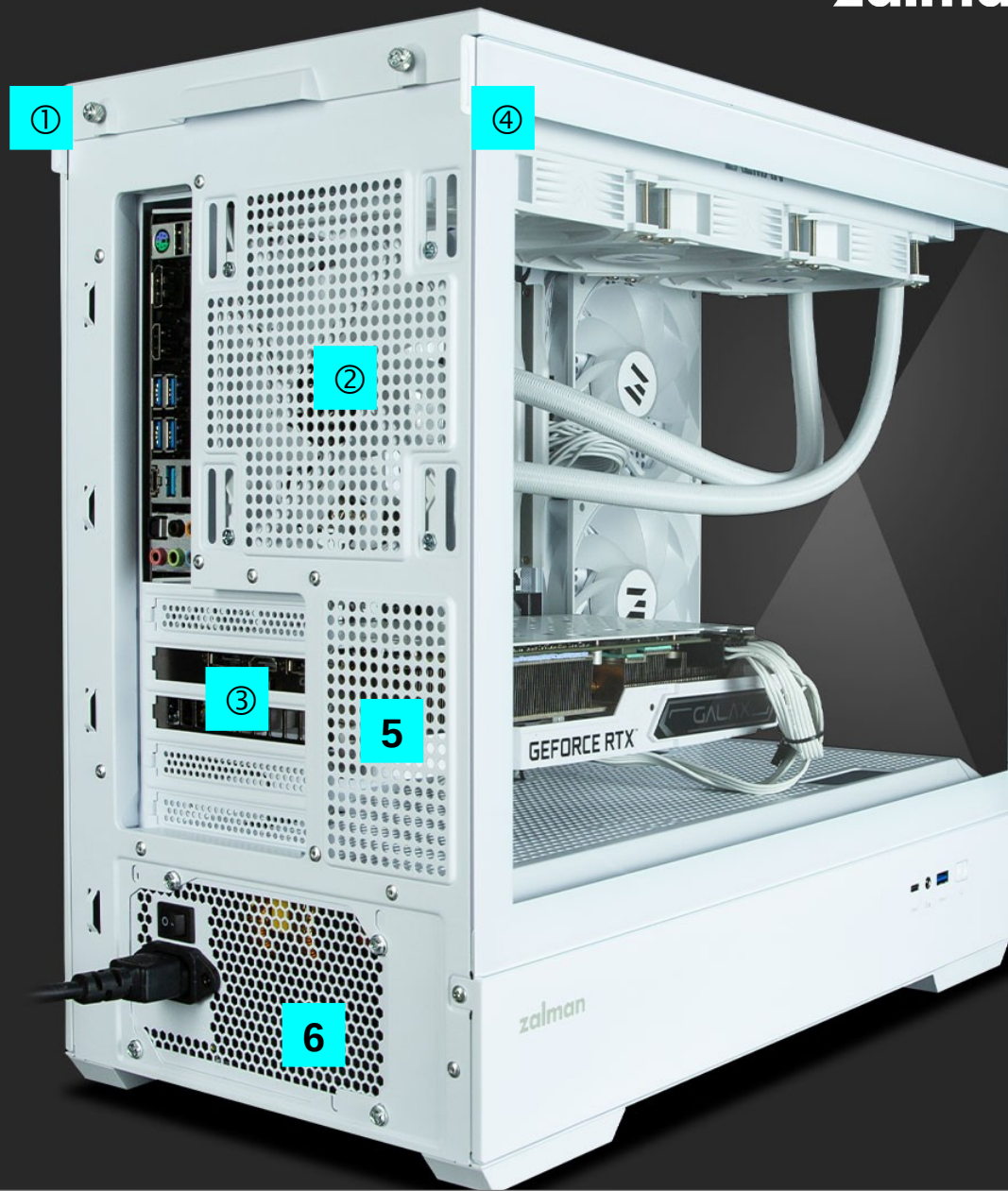

Rear Layout

1. Rear hand screw
2. Rear 120mm ARGB fan (Pre-installed)
3. PCI slots x 5
4. Side panel handle
5. Rear Air Vent
6. PSU Slot

Specifications

Model	Materials	Weight	Dimensions	Case Form Factor
P30	Steel, Plastic , Tempered Glass	8kg	453(D) x 235(W) x 429(H)mm	Micro-ATX Mini-Tower
Motherboard Support	Fans Support	Fan(s) Included	Drive Bays	Radiator Support
mATX / Mini-ITX	Top : 3 x 120mm / 2 x 140mm	Side : 2 x 120mm (ARGB Fan)	2 x Combo Bay (3.5" or 2.5", 1 x Guide toolless)	Top : 120mm / 140mm / 240mm / 280mm / 360mm
	Side : 2 x 120mm	Rear : 1 x 120mm (ARGB Fan)	1 x 2.5" Bracket	Rear : 120mm / 140mm
	Rear : 1 x 120mm / 1 x 140mm			
	Bottom : 3 x 120mm / 2 x 140mm			
Max VGA Length	Max CPU Cooler Height	Max PSU Length	PCI Expansion Slots	
420mm	173mm	200mm	5 pcs	
I/O Ports				
Power, 1 x USB 3.0 , 1 x Type-C				
Microphone + Headphone Jack,				