

# F12 PWM PST

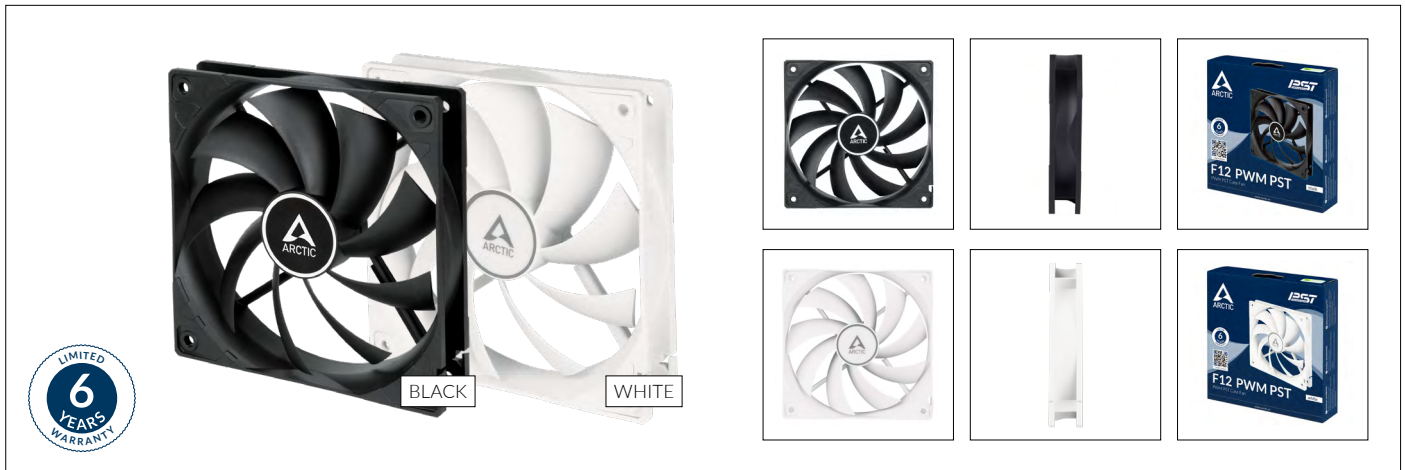

120 mm PWM PST Case Fan



## Fan Specifications

Dimensions	120 (L) x 120 (W) x 25 (H) mm
Weight	109 g
Speed	230-1350 rpm, 0 rpm <5% PWM
rpm Control	Pulsweitenmodulation - PWM
Static Pressure	1.0 mmH <sub>2</sub> O
Airflow	53 cfm   90.1 m <sup>3</sup> /h
Bearing	Fluid Dynamic Bearing
Cable Length	400 mm
Connector	4-Pin Connector + 4-Pin Socket
Current   Voltage	0.24 A   12 V
Starting Voltage	6.0 V
Noise Level	0.3 Sone
Ambient Operating Temperature	0-40 °C

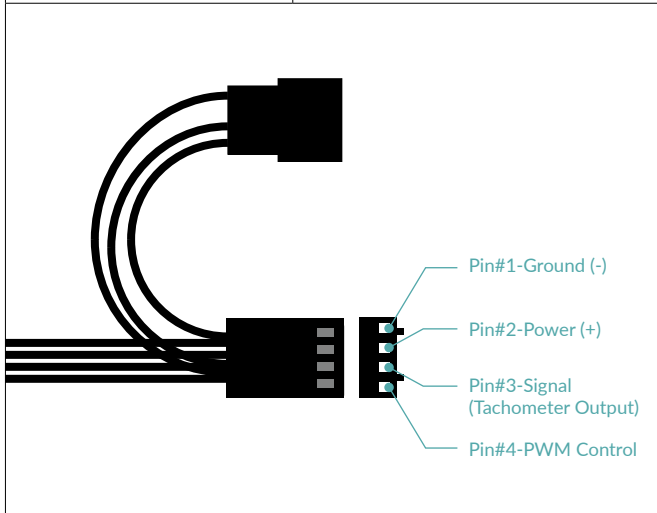

## Shipping Information Single Fan - Black

Dimensions	123 (L) x 123 (W) x 27 (H) mm
Weight	146 g
SKU	ACFAN00200A
EAN	4895213702966
UPC	840033400763
Package Content	F12 PWM PST x1 Mounting Screws x4

## Shipping Information Single Fan - White

Dimensions	123 (L) x 123 (W) x 27 (H) mm
Weight	146 g
SKU	ACFAN00198A
EAN	4895213702935
UPC	840033400732
Package Content	F12 PWM PST x1 Mounting Screws x4

## Shipping Information Pack of 5 Value Pack - Black

Dimensions	128 (L) x 128 (W) x 124 (H) mm
Weight	692 g
SKU	ACFAN00250A
EAN	4895213703345
UPC	840033401159
Package Content	F12 PWM PST x5 Mounting Screws x20

# F12 PWM PST

120 mm PWM PST Case Fan

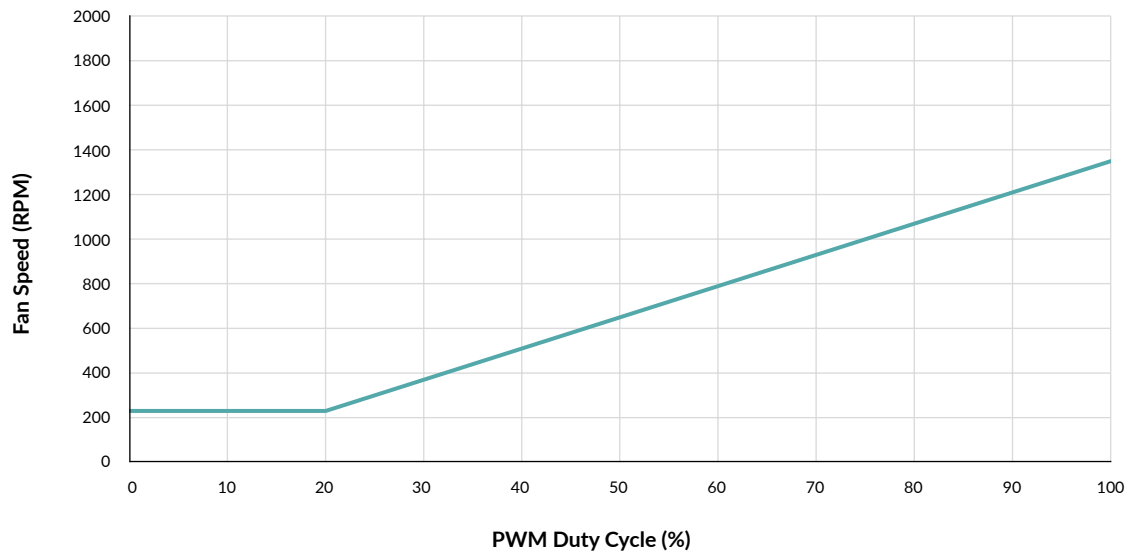
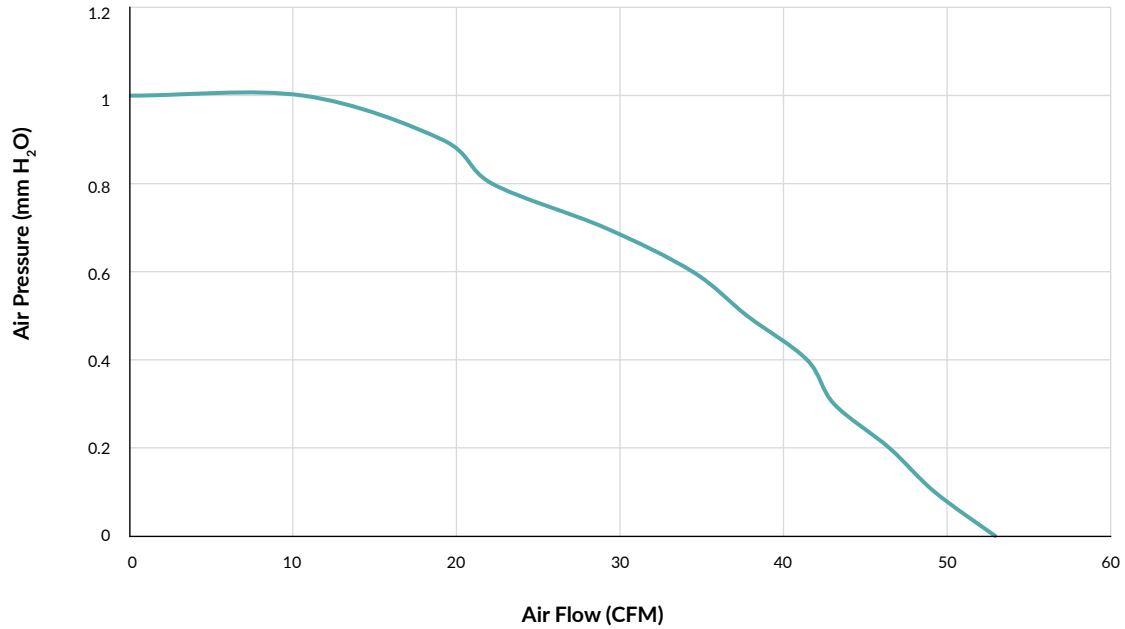

# F12 PWM PST

120 mm PWM PST Case Fan

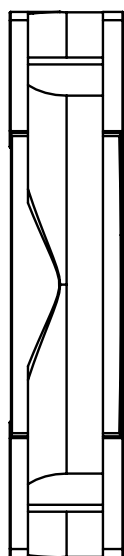
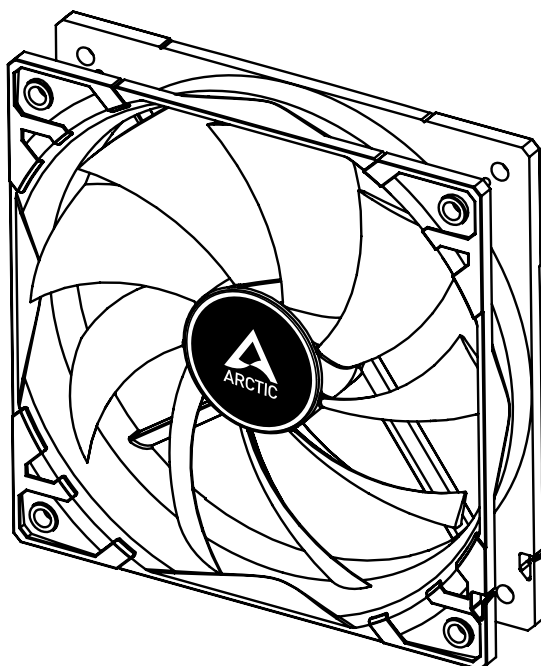

← 25 mm →

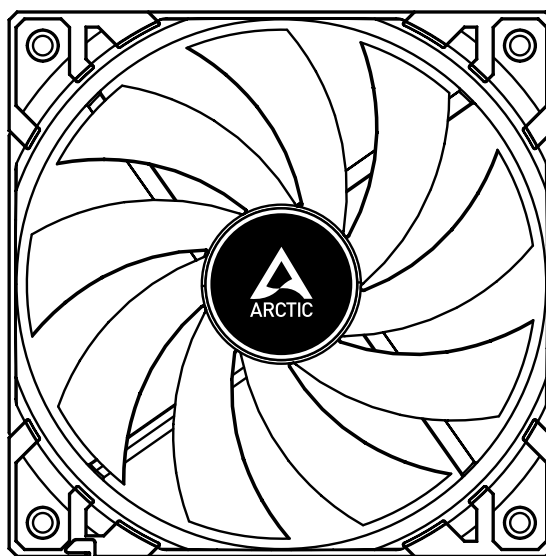

← 120 mm →



120 mm



All materials are compatible with RoHS requirements.

MORE INFORMATION



MANUALS

