

- **Style: Simple**
- **Size: Mid Tower supports up to E-ATX MB**
- **Material: Steel & Tempered Glass**

Main Features

- **Connection** : Front I/O ports with 2 x USB 3.0 & 1 x USB 3.2 (Gen 2) Type C
- **Ventilation**: Preinstalled 140mm ARGB front fan x 2 + 140mm rear fan x 1
- **Support** : Supports AIO cooling solutions



Specification

Model	Ceres 330 TG ARGB	Ceres 330 TG ARGB Snow	Ceres 330 TG ARGB Hydrangea Blue
P/N	CA-1Y2-00M1WN-01	CA-1Y2-00M6WN-01	CA-1Y2-00MFWN-00
Case Type	Mid Tower		
Chassis Dimension (H*W*D)	475 x 245 x 463 mm (18.7 x 9.65 x 18.23 inch)		
Net Weight	7.8 kg / 17.2 lbs.		
Panel	4mm Tempered Glass x 1		
Color	Black	White	Hydrangea Blue
Material	SPCC		
Cooling System	Front(intake): 140 x 140 x 25 mm CT140 ARGB fan (1500rpm, 30.5 dBA) x 2 Rear(exhaust): 140 x 140 x 25 mm CT140 (1500rpm, 30.5 dBA) x 1	Front(intake): 140 x 140 x 25 mm CT140 ARGB <u>white</u> fan (1500rpm, 30.5 dBA) x 2 Rear(exhaust): 140 x 140 x 25 mm CT140 <u>white</u> fan (1500rpm, 30.5 dBA) x 1	Front(intake): 140 x 140 x 25 mm CT140 ARGB <u>white</u> fan (1500rpm, 30.5 dBA) x 2 Rear(exhaust): 140 x 140 x 25 mm CT140 <u>white</u> fan (1500rpm, 30.5 dBA) x 1
Drive Bays	1 x 3.5", 2 x 2.5" or 3 x 2.5"		
Expansion Slots	7 (Rotatable Patented Design)		
Motherboards	6.7" x 6.7" (Mini ITX), 9.6" x 9.6" (Micro ATX), 12" x 9.6" (ATX), 12" x 13" (E-ATX)		
I/O Port	USB 3.2 (Gen 2) Type-C x 1, USB 3.0 x 2, HD Audio x 1		
PSU	Standard PS2 PSU (optional)		
Fan Support	Front: 3 x 120mm, 2 x 120mm, 1 x 120mm 2 x 140mm, 1 x 140mm Top: 3 x 120mm, 2 x 120mm, 1 x 120mm 2 x 140mm, 1 x 140mm Rear: 1 x 120mm, 1 x 140mm		
Radiator Support	Front: 1 x 360mm, 1 x 240mm, 1 x 120mm 1 x 280mm, 1 x 140mm Top: 1 x 240mm, 1 x 120mm 1 x 280mm, 1 x 140mm Rear: 1 x 120mm		
Clearance	CPU cooler max height: 185mm VGA max length: 340mm (with radiator) 370mm (without radiator) PSU max length: 220mm		

Packaging

Package Information	Ceres 300 TG ARGB	Ceres 300 TG ARGB Snow	Ceres 300 TG ARGB Hydrangea Blue
EAN Code	4713227539975	4713227539982	4711475641860
UPC Code	841163089989	841163089996	841163091876
N.W	7.8 kg / 17.2 lbs.		
G.W	9.1 kg / 20.06 lbs.		
Carton Size (L x W x H)	520.9 x 319 x 534.8 mm / 20.51 x 12.56 x 21.06 inch		
Cuft	3.14		
Container	w/o pallet		
20'	318 pcs		
40'	653 pcs		
40' HQ	741 pcs		



Appearance – Black version



Angle view



Left Side view



Front view



Right Side view



Internal Structure



Rear view



Top view



Bottom view

Appearance –
Snow version



Angle view



Left Side view



Front view



Right Side view



Internal Structure



Rear view

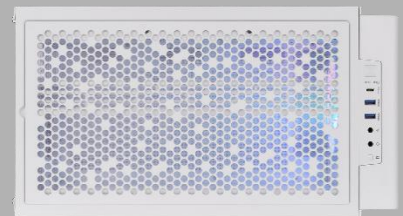

Top view

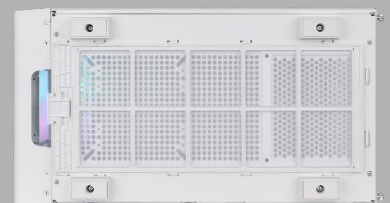

Bottom view

Appearance –
Hydrangea Blue



Angle view

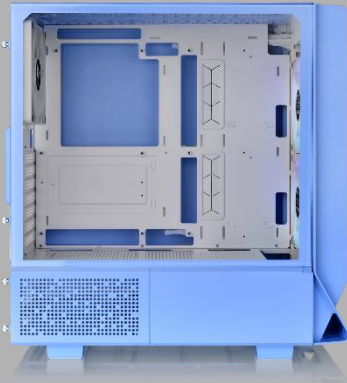

Left Side view

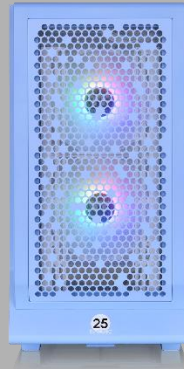

Front view

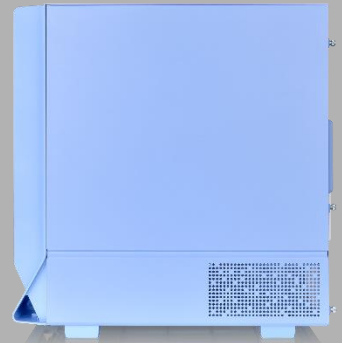

Right Side view

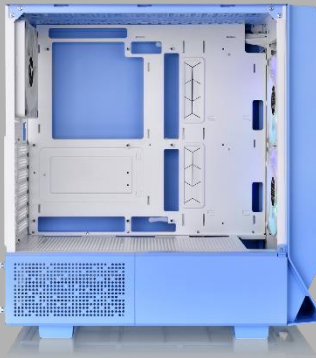

Internal Structure



Rear view

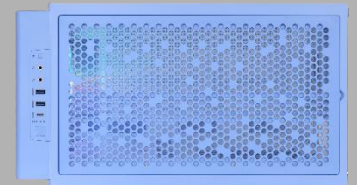

Top view

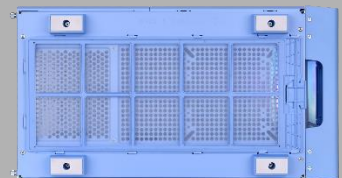

Bottom view



Thermaltake Ceres 330 Mid Tower Chassis

Unique Design



Compatible with Hidden-Connectors
Motherboard from ASUS and MSI

Clearance



Maximum support up
to 140mm fan x 5

Maximum radiator support
up to 360mm at front



Tempered Glass Window x 1

Structure (External)



USB 3.2 (Gen 2) Type-C x 1

USB 3.0 x 2

HD Audio



Full length power cover

Structure (Internal)

Preinstalled CT140
ARGB fan x 2 at front



Velcro Straps for better cable management

Structure (Internal)

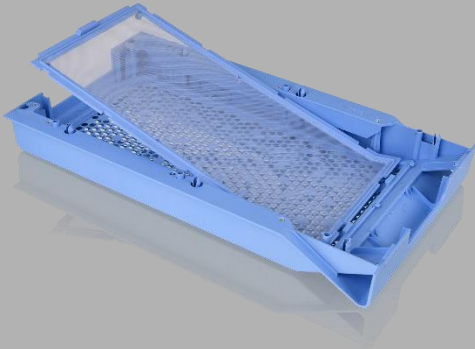

Front filter

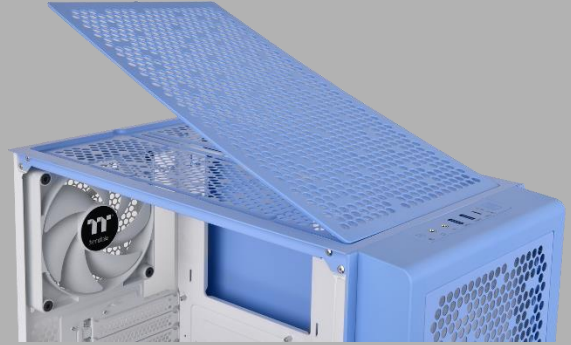

Top filter



Bottom filter



Left side filter



Right side filter

Rotational VGA bracket design



Horizontal VGA installation



Vertical VGA installation



Supports 90° riser cable installation



Three places for riser cable installation

Structure (Internal)

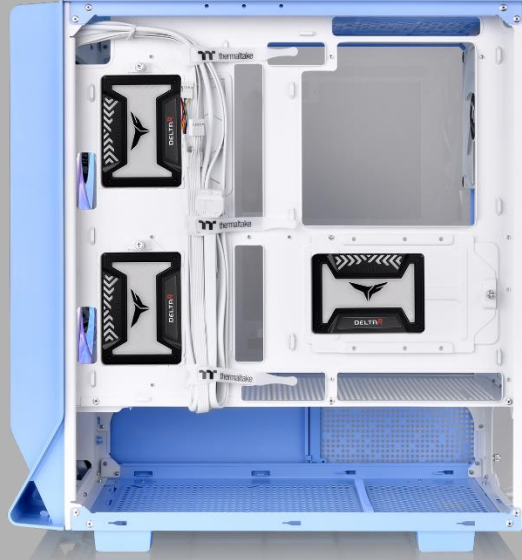

Maximum support up to **2.5" SSD x 3**



Maximum support up to **3.5" HDD x 1**

Pre-installed ARGB Fans



Pre-installed two hydraulic bearing **CT140 ARGB** fans which can effectively lower the operation noise and enhance the thermal efficiency.



Black Version



Snow / Hydrangea Blue Version

SPEC for Case ARGB **CT140 ARGB** fans

- Fan Speed: 500~1500 RPM
- Max. Fan Airflow: 77.37 CFM
- Max. Fan Air Pressure: 2.3 mm-H2O
- Fan Noise Level: 30.5 dBA
- Fan Bearing: Hydraulic bearing

Compatibility List

Fan Compatibility List			
	120mm	140mm	200mm
Front	3	2	-
Top	3	2	-
Rear	1	1	-

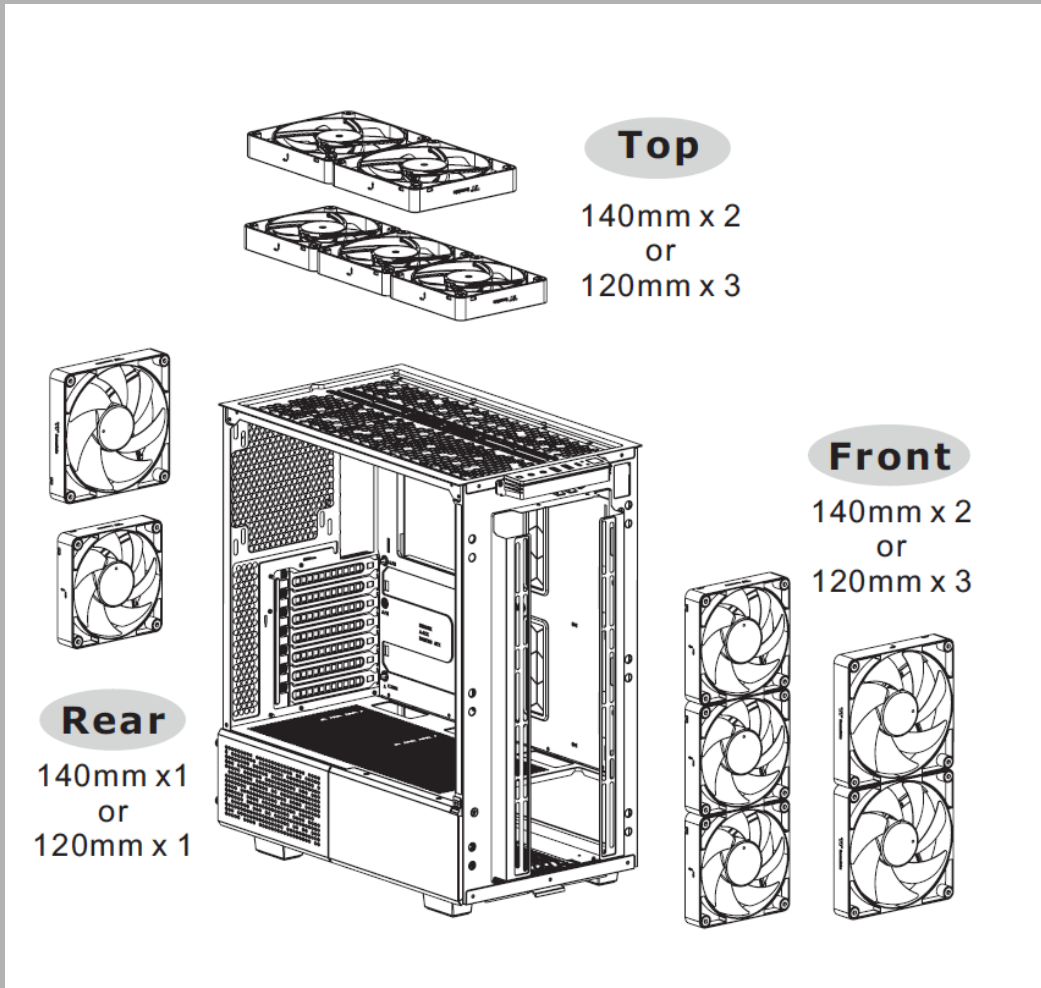

All-in-One Compatibility

All-in-One Compatibility List						
	120mm	240mm	360mm	140mm	280mm	420mm
Front	●	●	●	●	●	-
Top	●	●	-	●	●	-
Rear	●	-	-	-	-	-

